

T10 Workstation Guiding Book

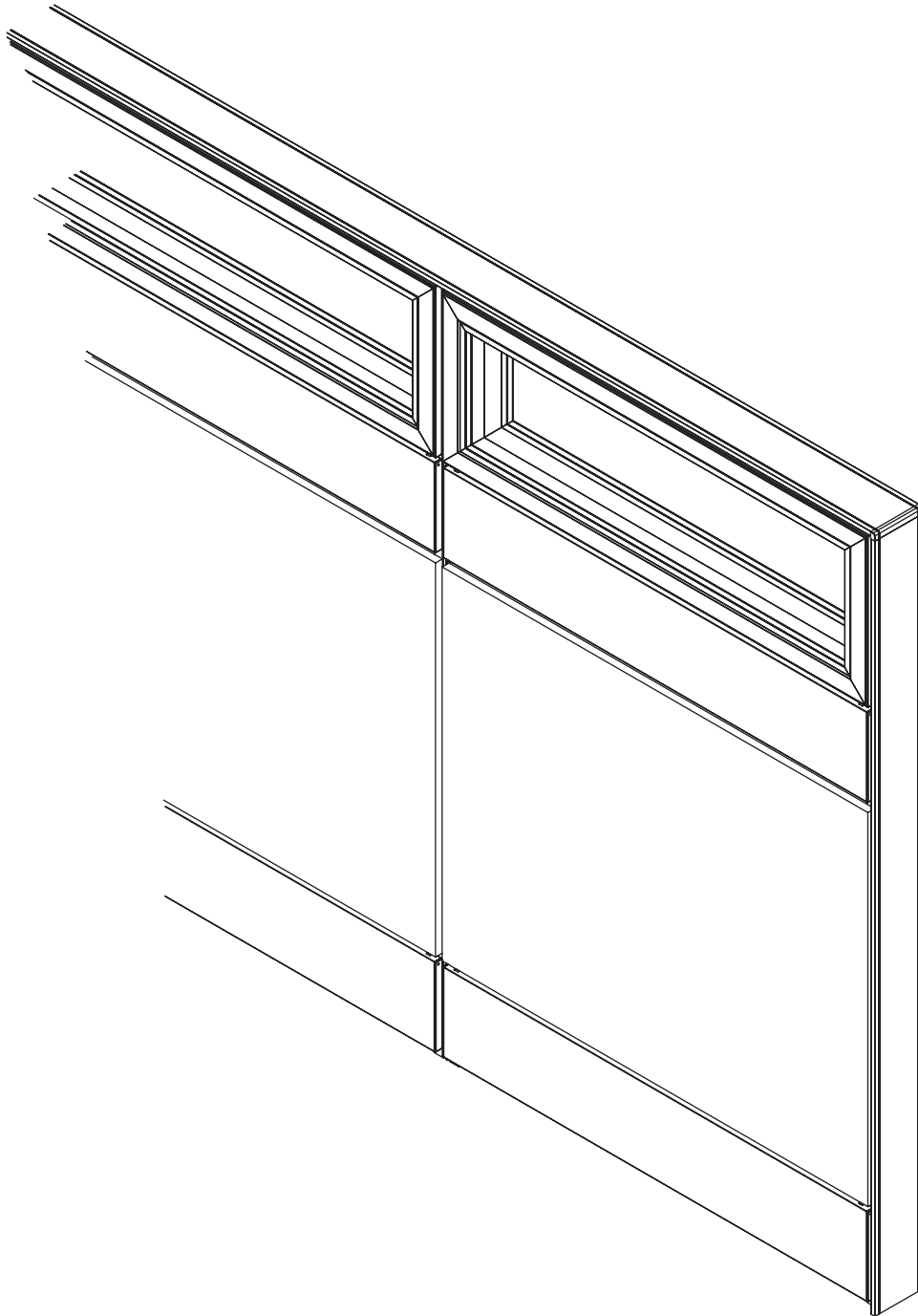

Clover

T10

Aluminum profiles list

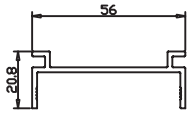

A pole
3908#
0.52kg/m

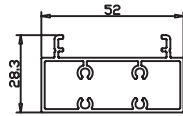

top bar
3915#
0.70kg/m

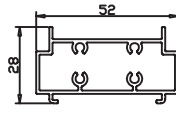

bottom bar
3917#
0.69kg/m

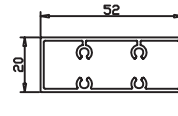

connection bar
3918#
0.62kg/m

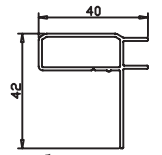

glass groove
3959#
0.34kg/m

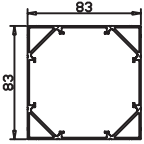

column
3910#
1.85kg/m

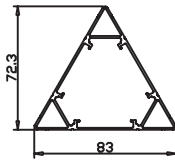

120° pole
3912#
1.24kg/m

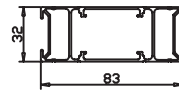

thin-wide pole
3914#
1.19kg/m

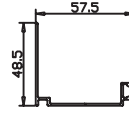

bottom groove
3968#
0.46kg/m

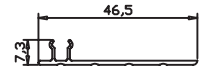

bottom seal
3969#
0.18kg/m

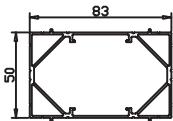

door pole
3970#
1.47kg/m

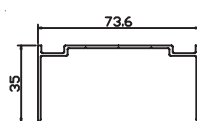

top groove
4043#
0.51kg/m

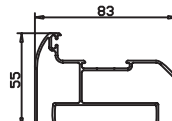

door frame
3972#
1.11kg/m

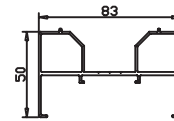

side pole
3973#
1.17kg/m

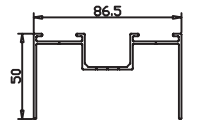

side groove
3974#
1.01kg/m

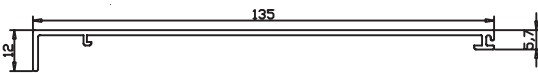

cable channel
3907#
0.66kg/m

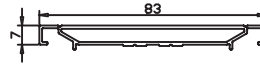

side cover
3911#
0.56kg/m

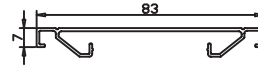

top cover
3909#
0.44kg/m

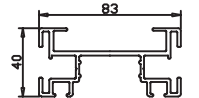

top bar
3975#
1.70kg/m

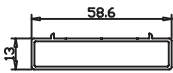

enhanced pole
4005#
0.48kg/m



hinge
4002#
0.65kg/m

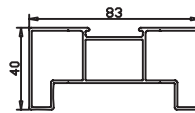

full glass frame(V)
4009#
1.20kg/m

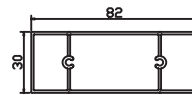

full glass frame(H)
4010#
1.00kg/m

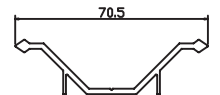

top sealing connector
4041#
0.55kg/m

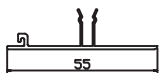

top sealing
4042#
0.27kg/m

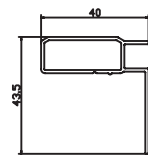

glass groove
3992#
0.35kg/m

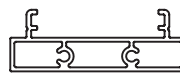

added-on top bar
4205#
0.59kg/m

Plastic profiles list

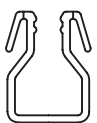

mid sealing
H 116



side sealing
Pv54



cable channel seal
U119-25

Other components

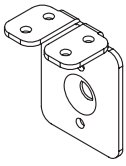

single foot

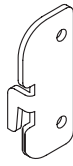

tile hook (L/R)

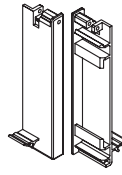

cable channel side cap (L/R)

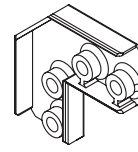

glass groove connector

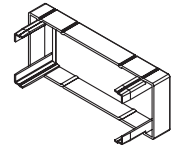

thin-wide cap

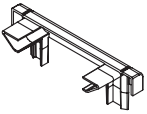

side top cap

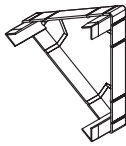

120° cap

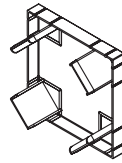

square cap

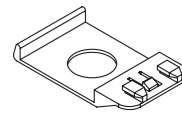

connection position for A pole

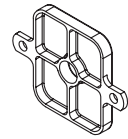

connection position for column

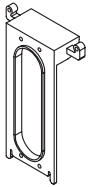

cable channel connector

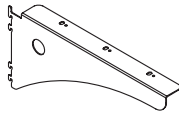

big bracket (L/R)

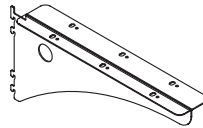

double side bracket

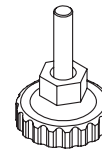

adjustor (M8)

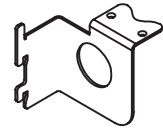

small bracket (L/R)

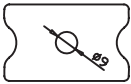

panel connector F

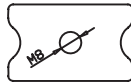

panel connector M

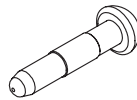

dowel pin

M8*20 bolt corner connection
 M8*30 bolt 180 degree connection
 M8*40 bolt side pole connection
 M8*60 bolt side pole vertical adjustment

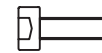

M4*80 chipboard screw
 M4*30 chipboard screw
 M4*20 chipboard screw



hinge

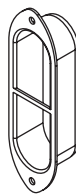

wire guard



ceiling adjustor



added-on connector

Toolings list

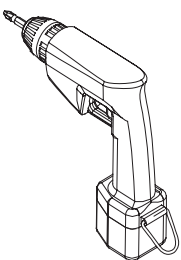

electric screw driver

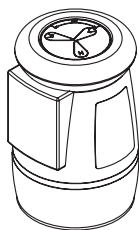

gradienter

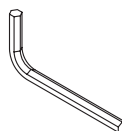

allen key

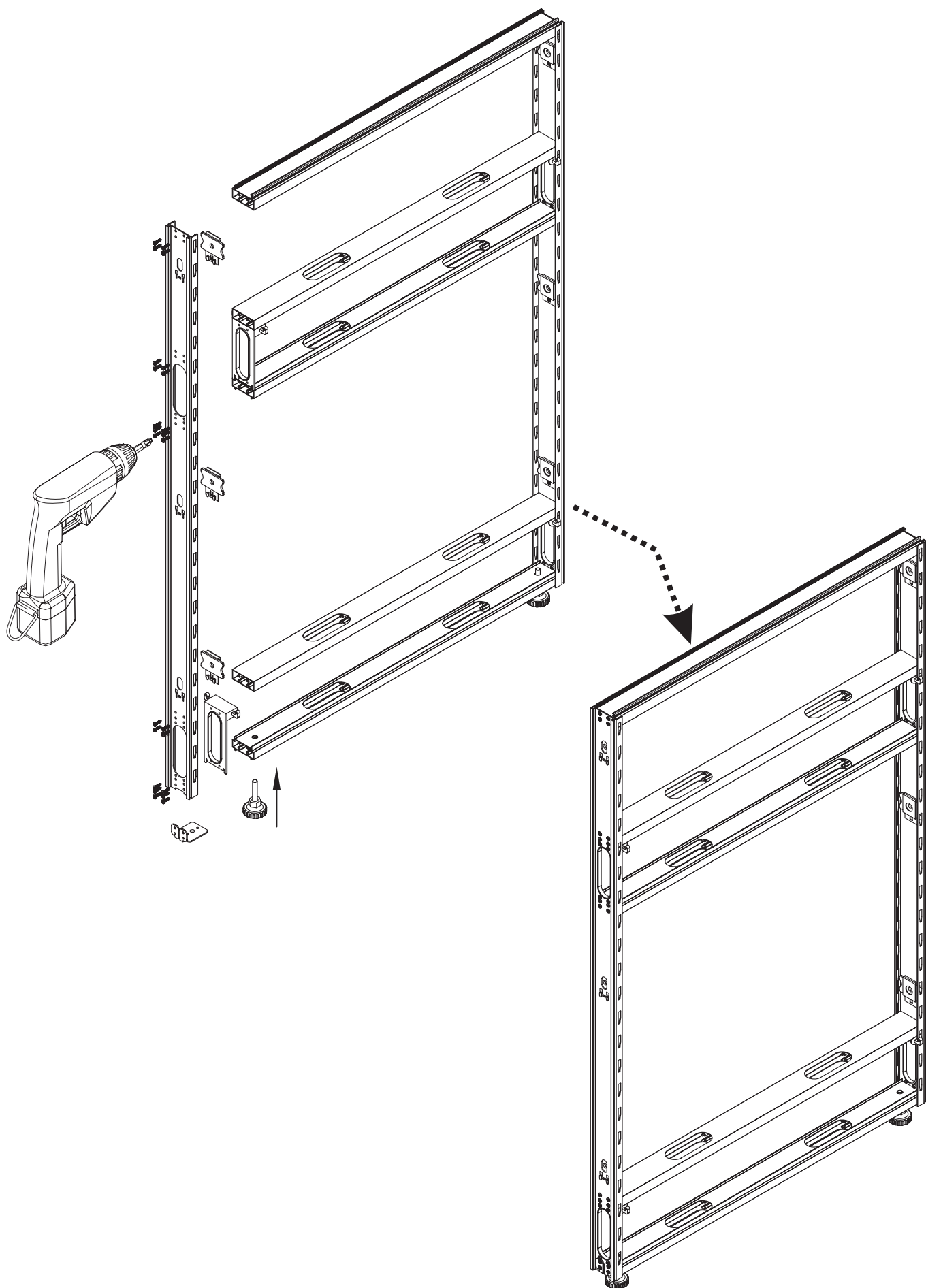

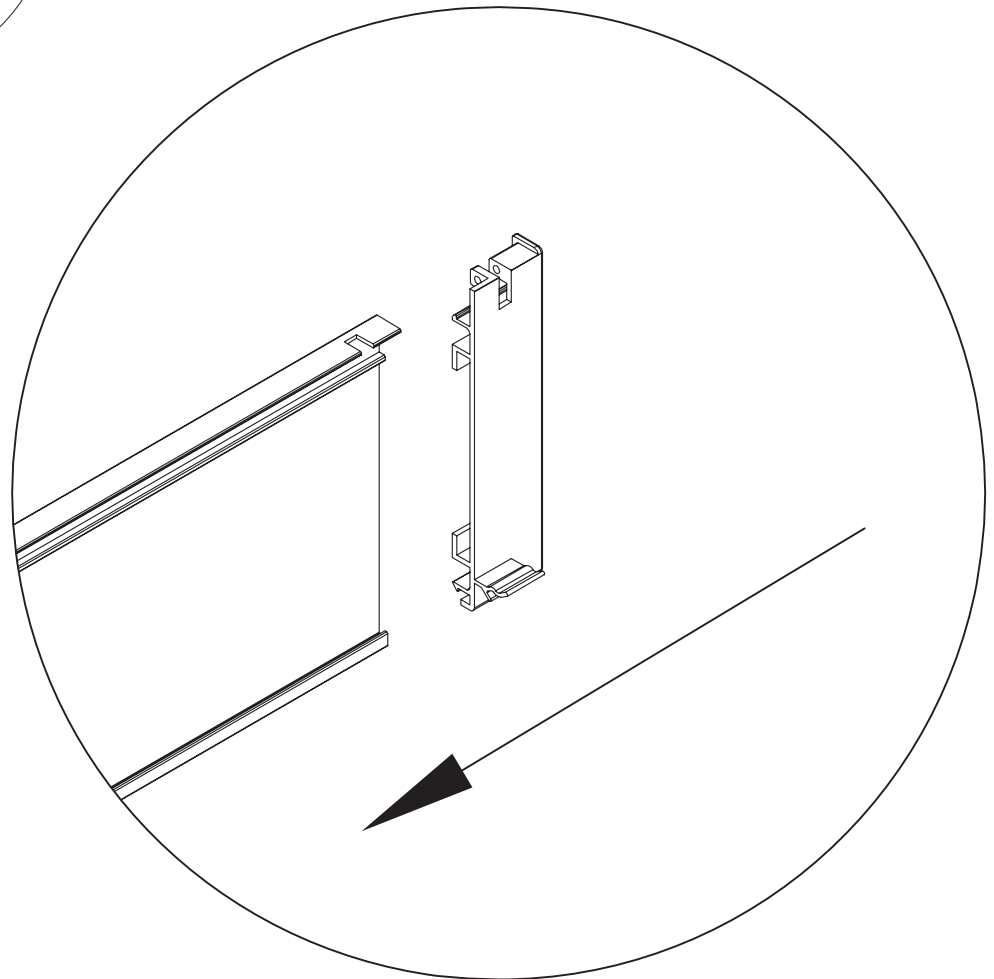
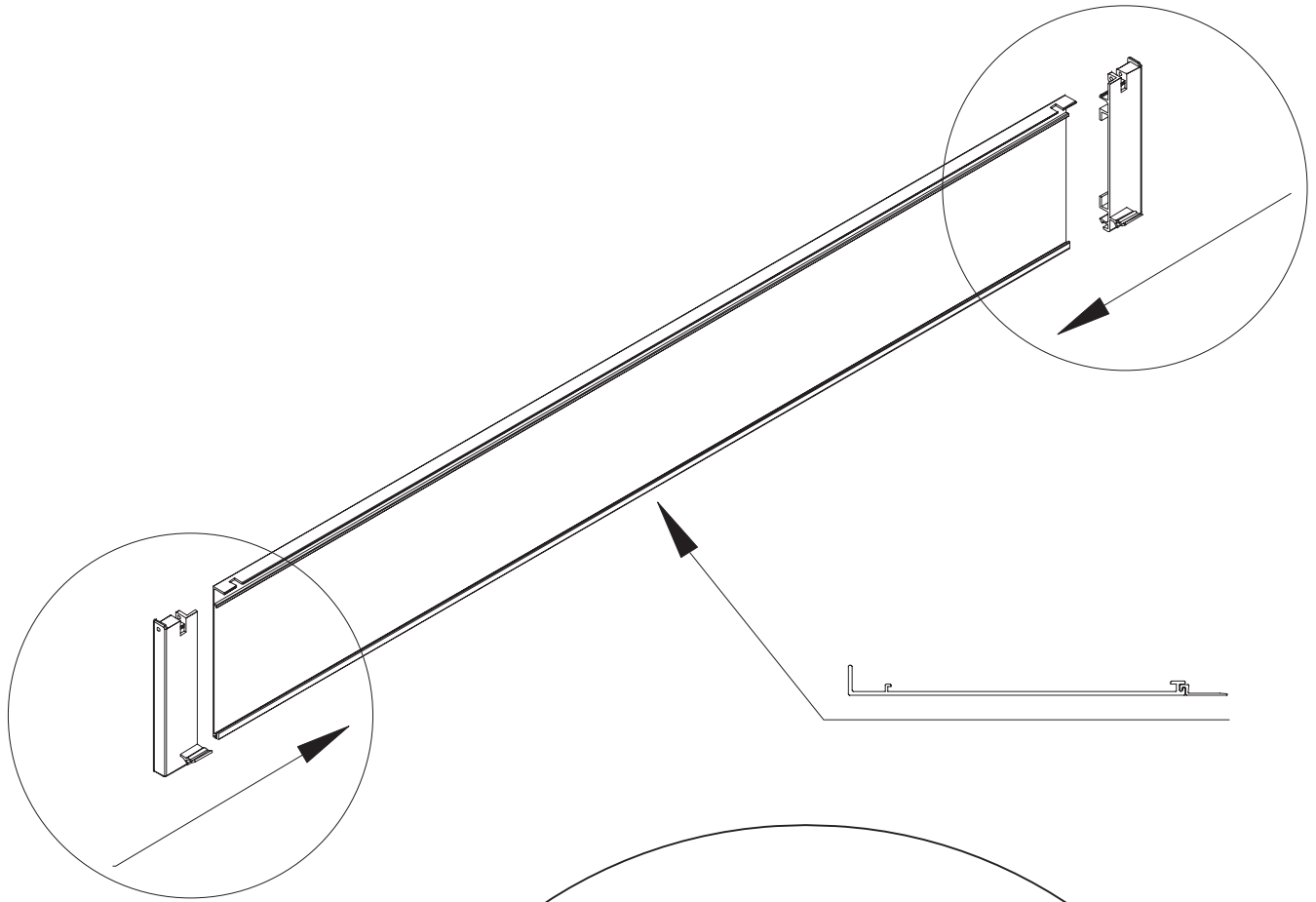

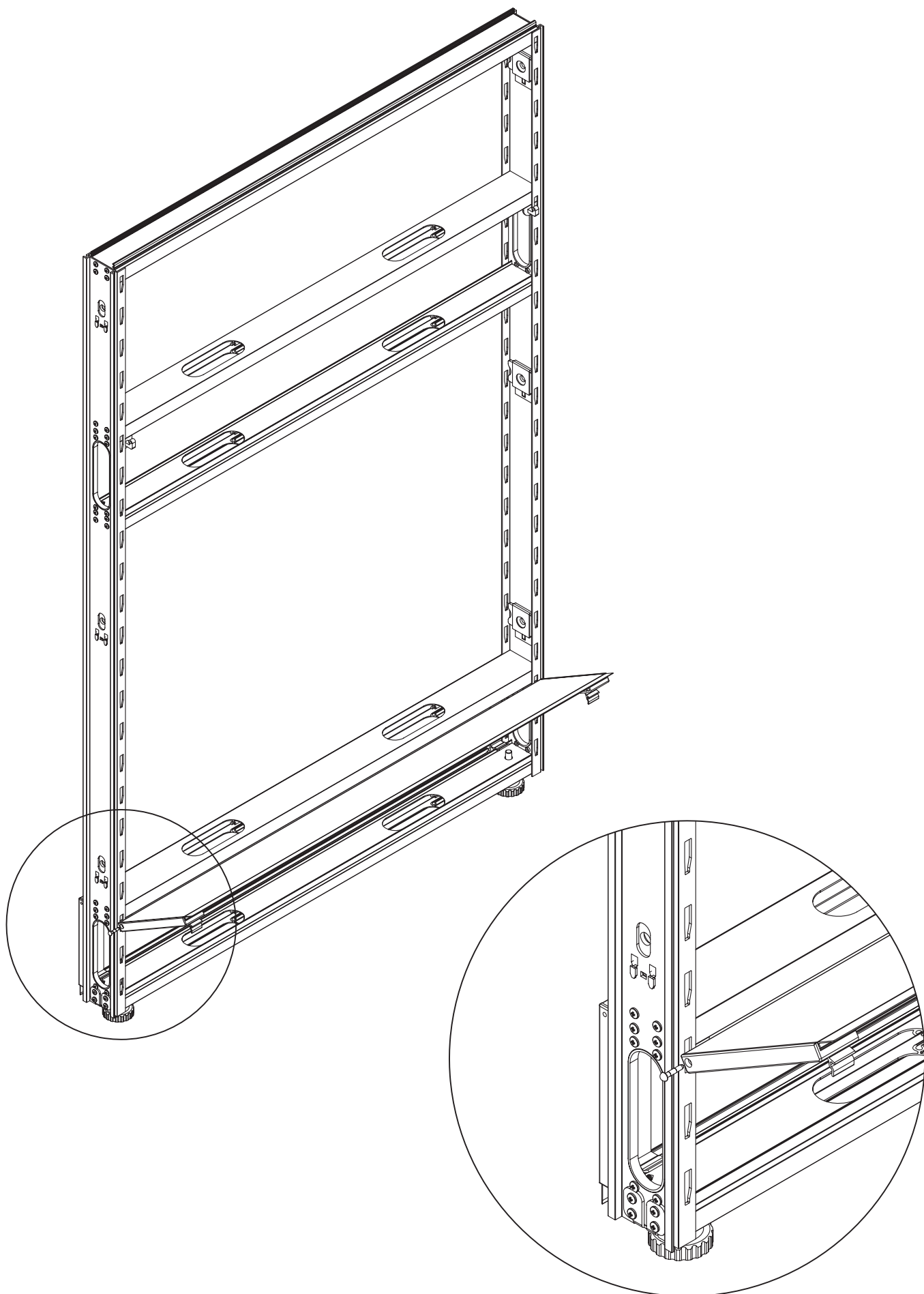

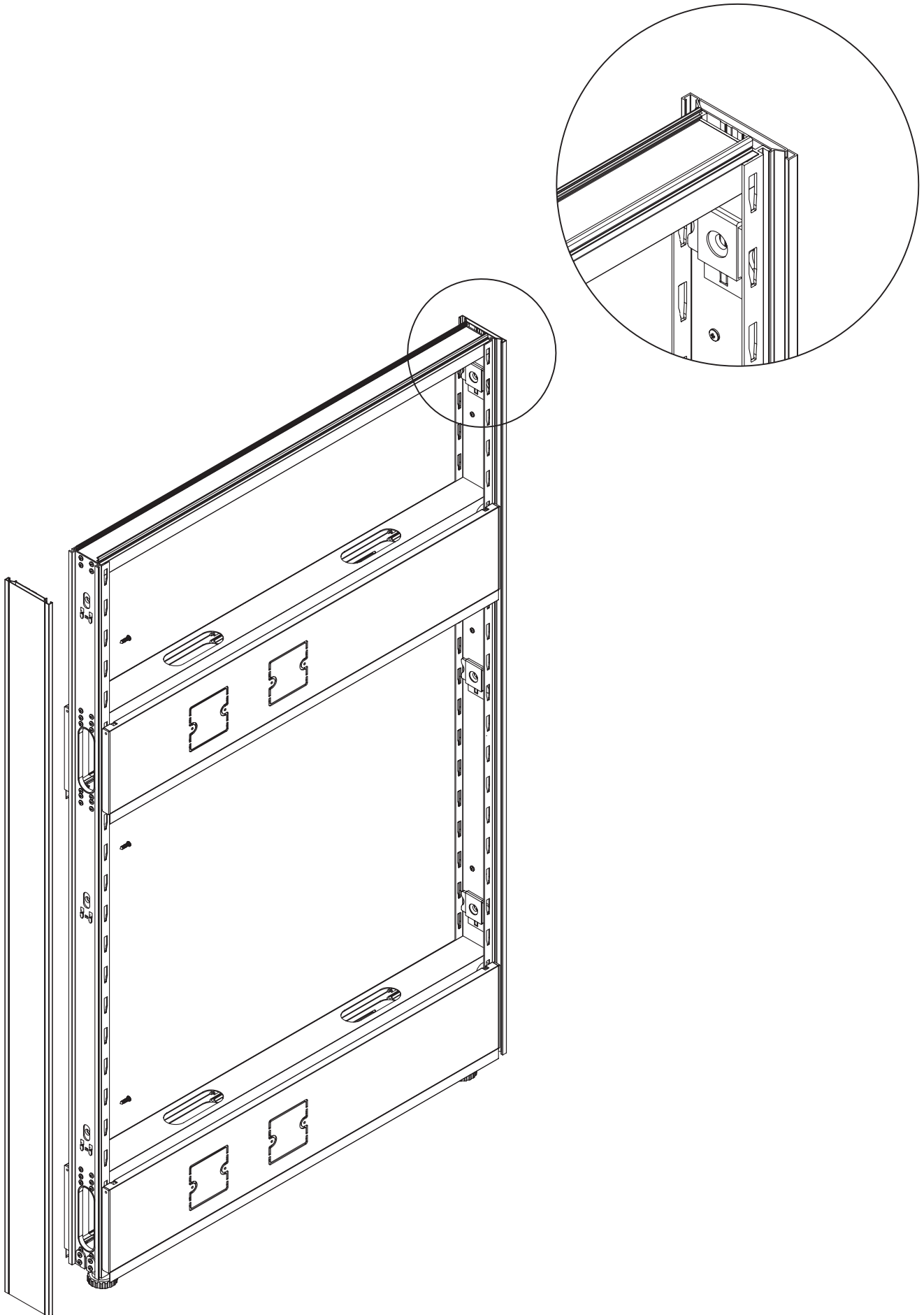

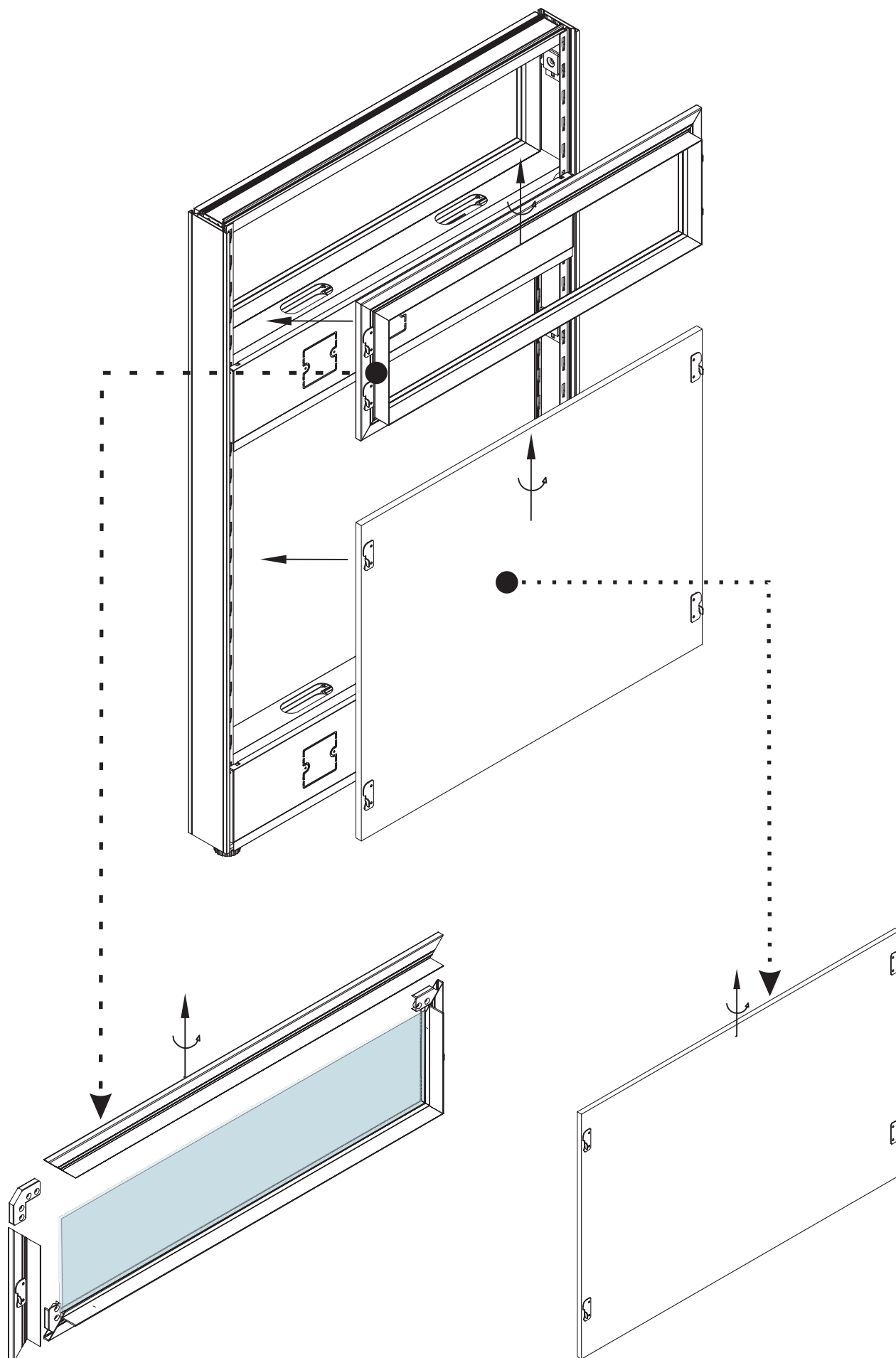

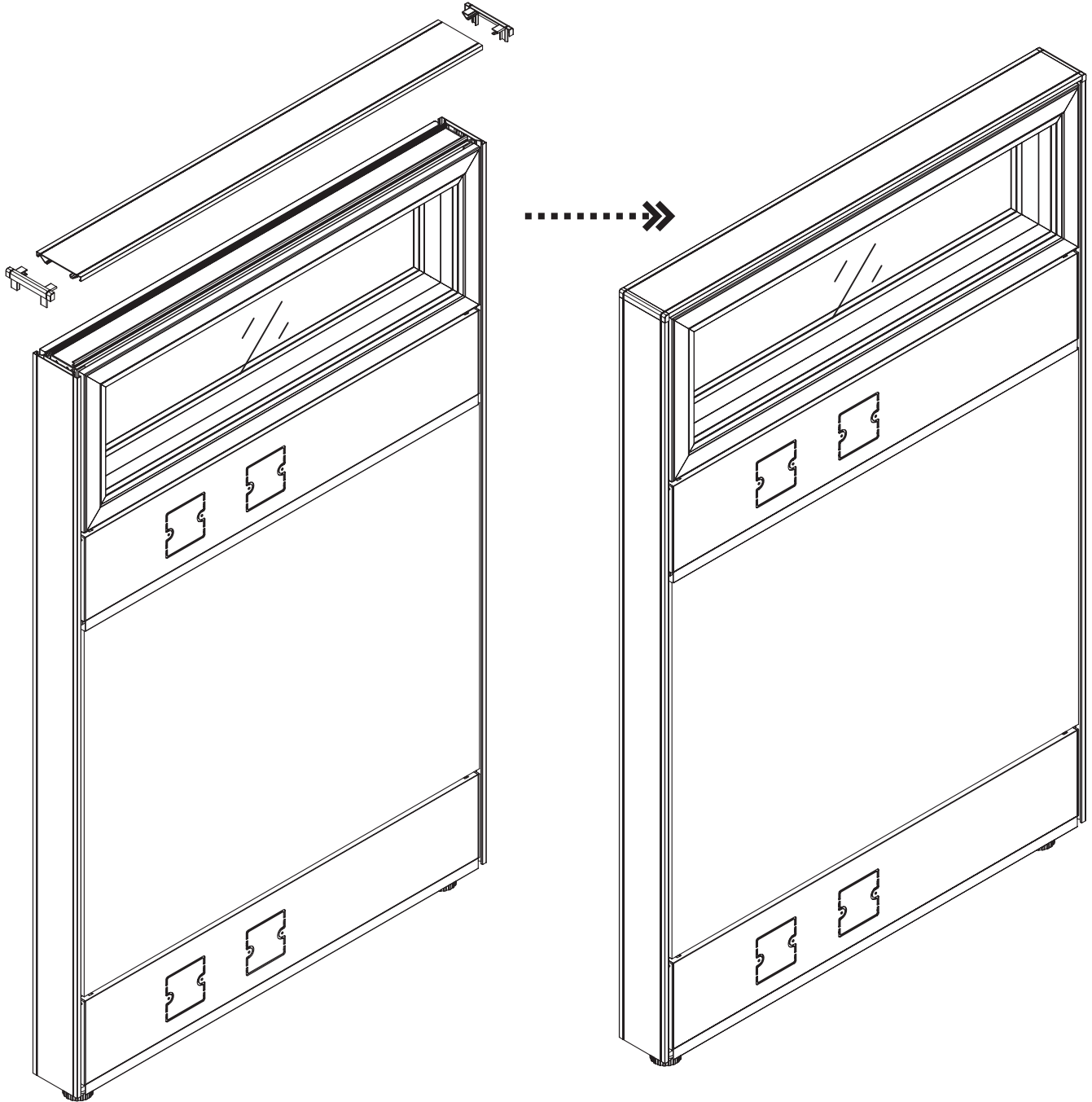

Clover

T 10

